

Digital Color Scanning Sonar SCS-60

Display section:

- (1)PPI image by TFT liquid crystal color display
- (2)Display resolution 1280 x 1024 (SXGA) *Option is available
- (3)Display colors Sonar image: 32 colors Character: 4-color display
- (4)Display mode Head-up, north-up, and true motion
- (5)Sub-image External input signal display, audio/fish finder/fish school information (switchable display)
- (6)Off-center When RM mode, it is displayed in arbitrary directions
- (7)Image adjustment When tilting, distance adjustment of wake mark
- (8)Information display Own vessel information (longitude, latitude, speed, direction, and bow direction)
Fish school information (histogram)
Water temp./depth information (graph)
Current information (3-layer)
Net depth information (4 points)

- (2)Stabilization ±20 degrees
- (3)Frequency 58kHz, 62kHz
- (4)Transmission output reduction (10 steps)
- (5)Pulse width 0.4~36ms
- (6)Other function Vertical beam width variable

Receiving:

- (1)Receiving method: Straight amplifier Digital beam forming
- (2)Stabilization ±20 degrees
- (3)Other functions AGC, TVG, RCG, Variable horizontal and vertical beam width

Tilt angle range:

-3° ~60°

Beam width:

Transmission Horizontal: 360° Vertical: 7°
Reception Horizontal: 19° Vertical: 12°

Hoist Unit:

- (1)Stroke 600mm ※OPTION 900mm
- (2)Water resistance against vessel speed 18 knots

Power Consumption:

DC24V(DC20~32V)
Average 0.5kW (max, 30A when starting hoist up and down)

Measurement (W × H × D) & Weight:

I-137 LCD	430mm × 460mm × 345mm	19kg
RC-25 Remote Controller	246mm × 158mm × 46mm	1kg
PRC-60B Processor	185mm × 320mm × 206mm	6kg
SR-88 TX/RX	479mm × 487mm × 344mm	34kg
M-120 Hoist Unit	413mm × 1687mm × 380mm	170kg

(With T-197 Transducer)

Range:

- (1)Horizontal range 50~5000m (selectable)
*off-center (enlarged 1.5 times in a desired direction not available over 5000m)
- (2)Fish-finder range 50~1000m (selectable)

Audio Frequency:

800 Hz (output for amplifier built-in speakers)

Transmission:

- (1)Tx method OMNI

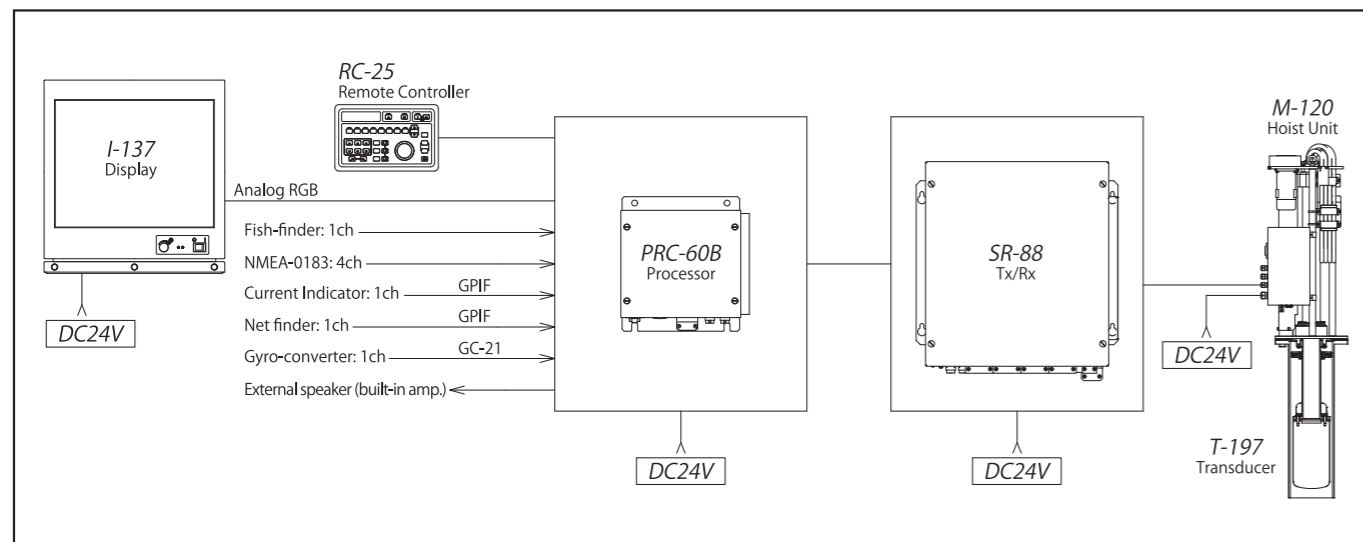

⚠ SAFETY PRECAUTION : Please be sure to read the Instruction Manual before operating

● Specifications are subject to change without prior notice for improvement.

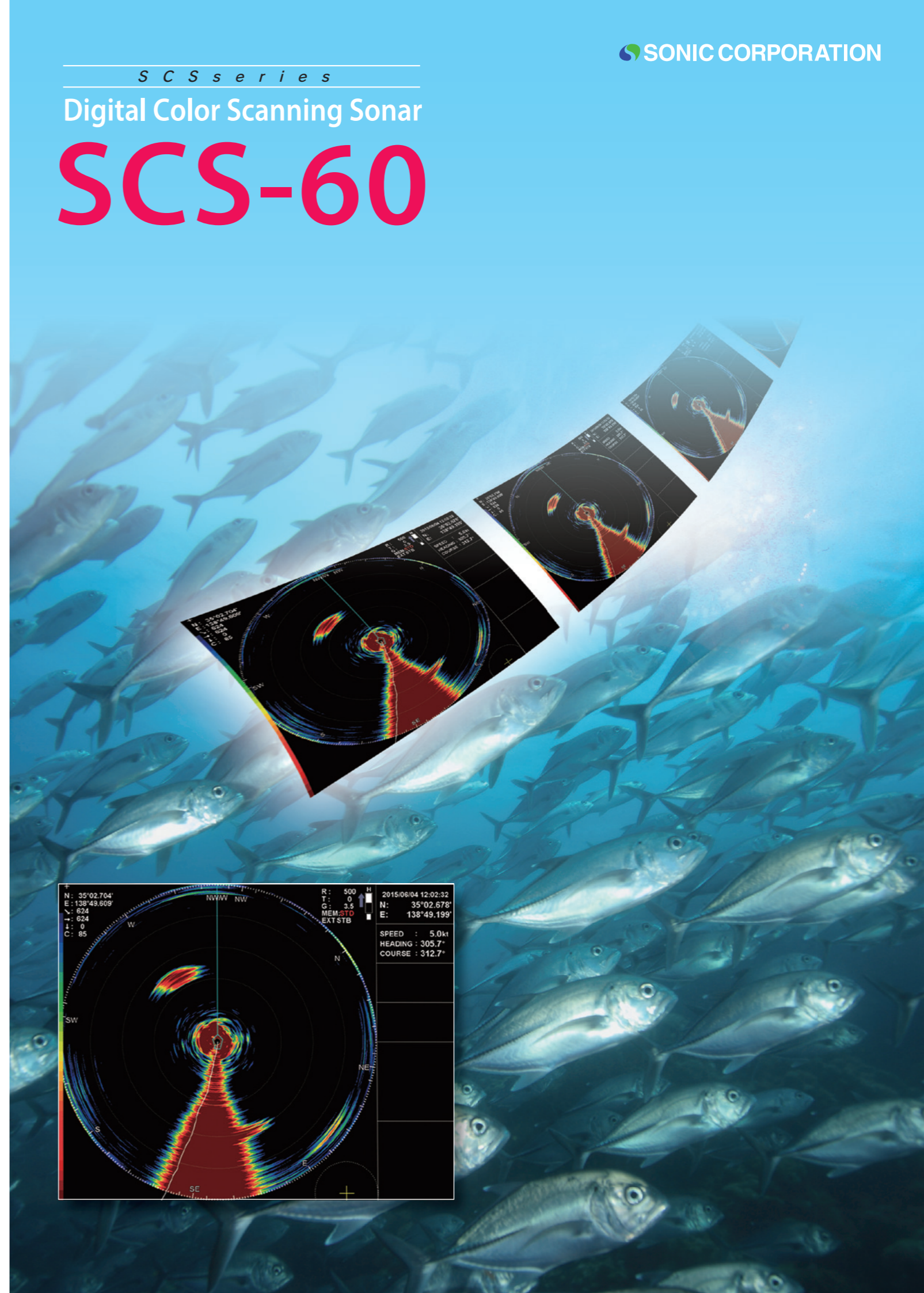

Complete Clarity Digital Color Scanning Sonar SCS-60

Even at a compact size, the SCS-60 features the same performances as a large-sized sonar system.

It is compact and cost-effective perfect for both large fishing vessels and mid/small-sized fishing vessels.

- ➔ One touch memory keys for recalling settings for the user's fishing style
- ➔ World-first compact sonar system with all-directions Tx/Rx stabilization
- ➔ Transmission wave level improved through an increase in the number of elements and digitized beam-form
- ➔ Hoist unit with guide ring offering safety and durability
- ➔ Downsized hoist unit, thus suitable for installation locations with space limitations

The more elements, the more power!

This transducer has 512 elements. Regarding compact sonar systems, the transducer features the largest numbers of elements currently available, when compared with other manufacturers. Even a compact size can still bring satisfaction to user's fishing.



Tx/Rx stabilization function

We realized an all-directions Tx/Rx stabilization function even for such a compact sonar system. The SCS-60 is the smallest sonar released by Sonic, but this function provides stable and effective fishing.

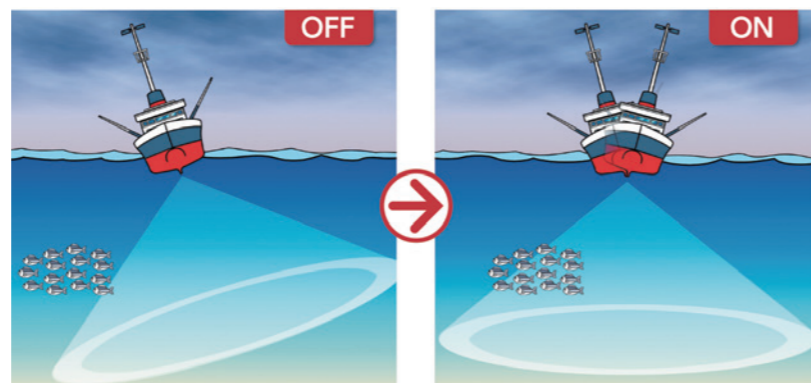

Safe and reliable transducer

All Sonic Hoists feature a structure with guide rings in order to withstand the harsh conditions present during marine use. Also, transducers are exposed to shocks in marine environments. Thus, Sonic uses a unique transducer covered with STAINLESS STEEL to protect it from damage. We adopted this unique technology for our compact sonar systems as well.



SCS-60's imaging quality

Our sonar has exceptional detection capabilities, easily displaying every fish on the seabed with fine detail.

Observable

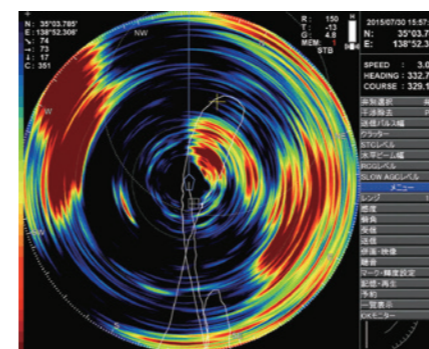

Range:150m

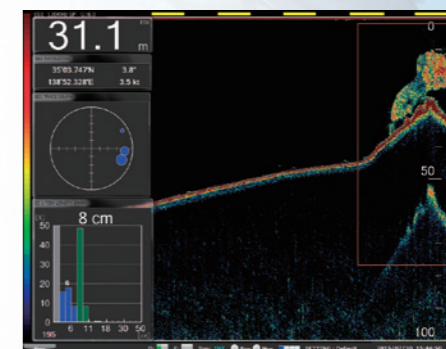
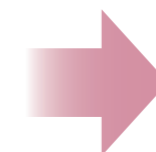

KSE-310(120kHz) Fish-sizing Echo Sounder
Target Fish (frigate tuna/frigate mackerel)

Observable

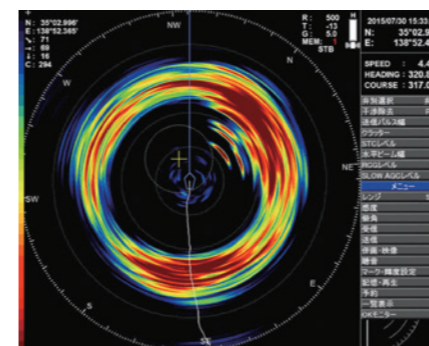

Range:500m

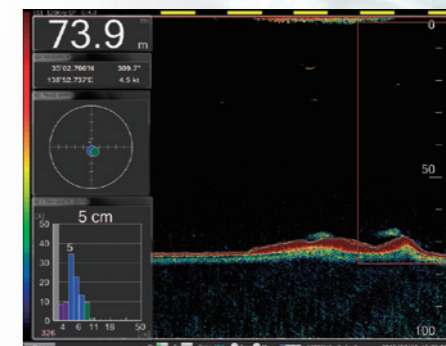
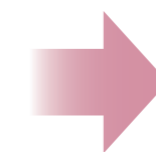

KSE-310(120kHz) Fish-sizing Echo Sounder
Target Fish (sardine/horse mackerel)